

ANT+ CONSOLE

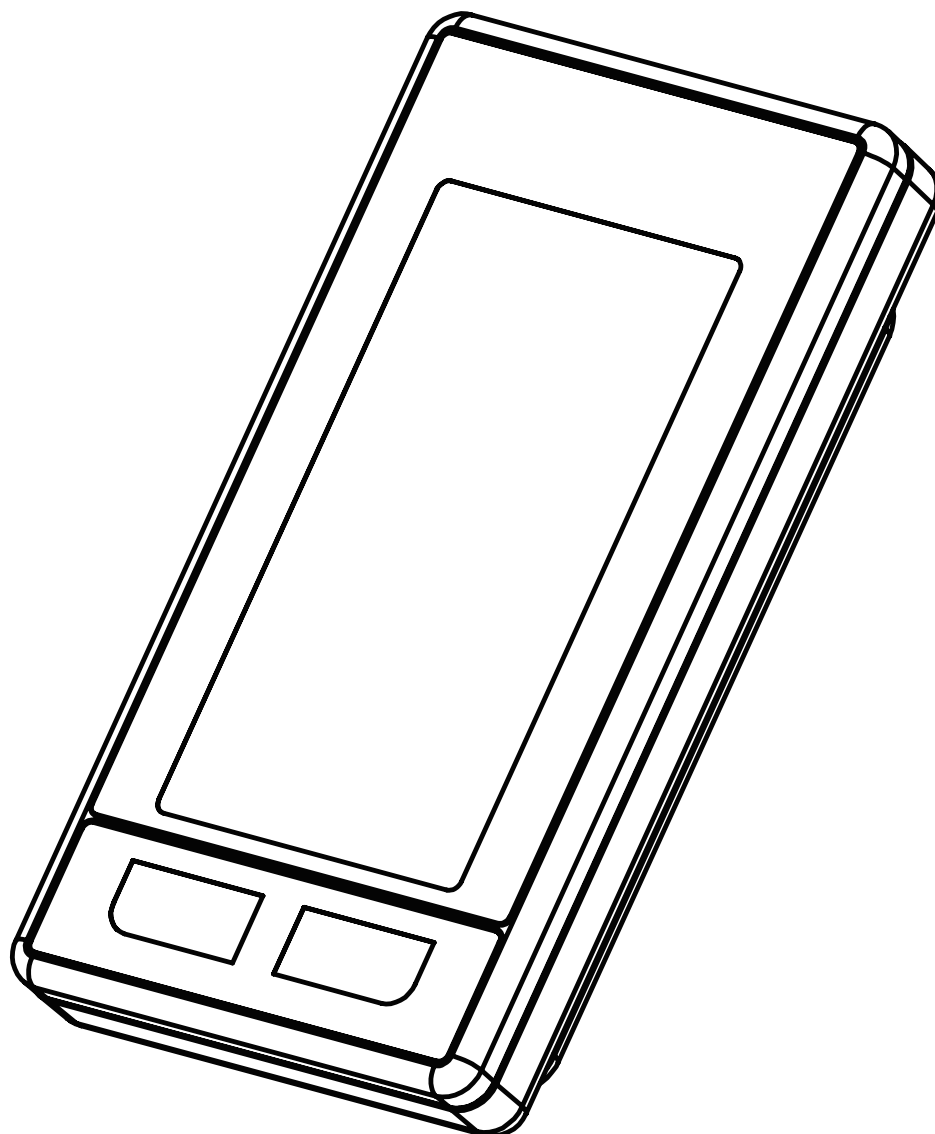

ICG PART NO:320-00-00001-01
PN NO:1000317935
ZMD NO:ZMD4001580



FCC COMPLIANCE & ADVISORY STATEMENT

This device complies with Part 15 of the FCC rules. Operation is subject to the following two conditions:(1) this device may not cause harmful interference, and (2) this device must accept any interference received, including interference that may cause undesired operation. This equipment has been tested and found to comply with the limits for a Class B digital device, according to Part 15 of the FCC rules. These limits are designed to provide reasonable protection against harmful interference in a residential installation. This equipment generates, uses and can radiate radio frequency energy and if not installed and used in accordance with the instructions, may interfere with radio communications. However, there is no guarantee that interference will not occur when installed as instructed. If this equipment does cause harmful interference to radio or television reception, which can be determined by turning the equipment off and on, the user is encouraged to try to reduce the interference by one or more of the following measures:

FCC COMPLIANCE & ADVISORY STATEMENT

1. Reorient the receiving antenna.
2. Increase the separation between the equipment and receiver.
3. Connect the equipment to an outlet on a circuit different from that to which the receiver is connected.
4. Consult the dealer or an experienced radio/TV technician for help.

Any special accessories needed for compliance are specified in the instruction manual.

WARNING:

A shielded-type power cord is required in order to meet FCC emission limits and also to avoid interfering with any nearby radio and television reception. It is essential that only the supplied power cord is used. Use only shielded cables to connect I/O devices to this equipment.

ATTENTION: Any changes or modifications not expressly approved by the party responsible for compliance could void your authority to operate the equipment.

LIMITED WARRANTY

Indoorcycling Group GmbH warrants that all new equipment will be free of manufacturing defects in workmanship and materials. ANT+ console 320-00-00001-01 is developed for the use in professional class environments and therefore designed for commercial applications. Incorrect assembly, incorrect use or outside mechanical damages can void the warranty terms.

1 Year Warranty: ANT+ Console.

The warranty becomes effective on the date of original installation

Batteries are excluded from any warranty.

PARTS INCLUDED

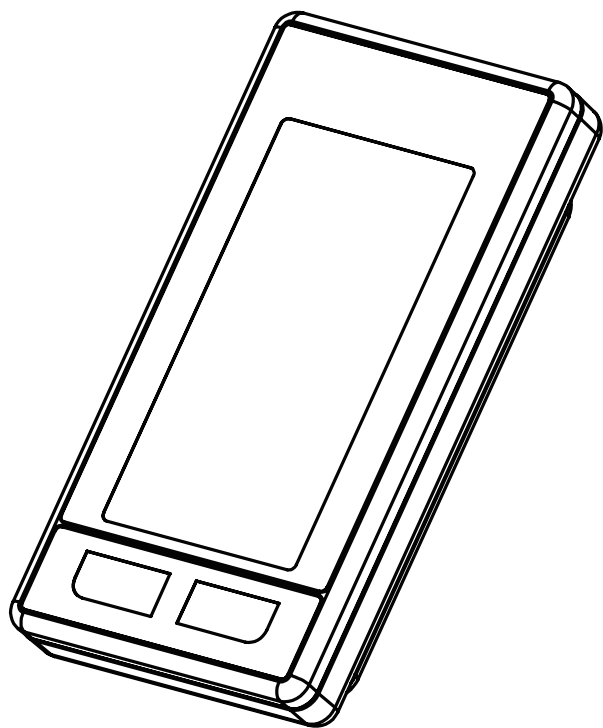

A. X1

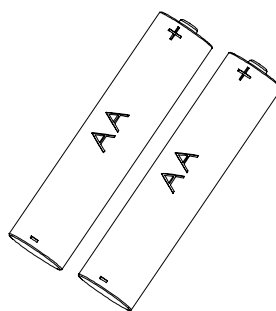

B. X2

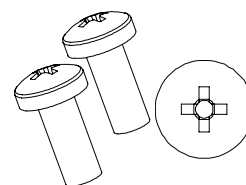

C. X2

TOOLS REQUIRED

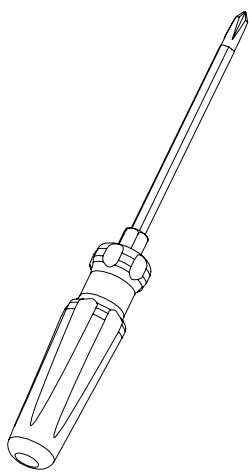

PH2

ASSEMBLY

1

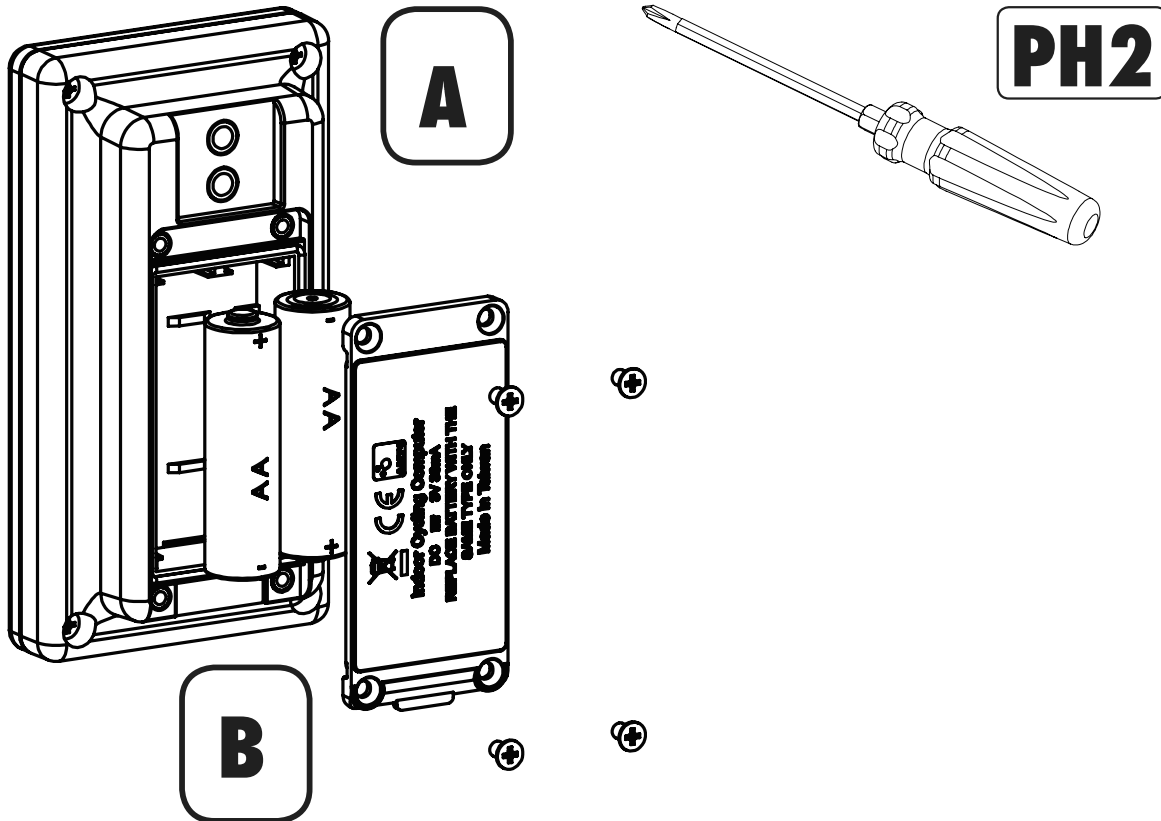

The use of rechargeable batteries may lead to malfunction of the console unit due to a voltage lower than 1,5 V.

TECH SPECS & FEATURES

TECHNICAL SPECIFICATIONS:

- Wireless (ANT+) data transmission.
- Compatible with analog (5.5 kHz Polar® heart rate devices (intergrated Polar® HR receiver).
- Supports ANT+ chest belts.
- Display background illumination (5 sec.).
- Simple operation via “SUN” and “FLOW” buttons.

TRAINING FEATURES:

- Heart Rate reading (actual and average).
- Cadence/RPM reading (actual and average).
- Training Duration.
- Display background illumination (5 sec.).
- Calorie consumption (calorie calculation requires heart rate signal; the shown calorie consumption is based on average values and should only be used for reference purposes).
- Scan functionality for time, distance and calories.

BASIC SETTINGS

Basic settings must be done during the assembly process. Before you start with the basic settings, make sure everything is assembled properly to the bike or KRANKcycle.

Basic settings include:

- Pairing of ANT+ RPM transmission.
- KM/MILE settings.
- Gear Ratio settings.

Basic settings process:

- Keep one button pressed while inserting batteries into the ANT+ console to enter maintenance mode.
- Press "SUN" button to display software version.
- Press "SUN" button to enter ANT+ RPM pairing mode.

BASIC SETTINGS

- Press "FLOW" button to start ANT+ RPM pairing.
(Put the console as close as possible to the transmitter and provide RPM signal during the pairing process).

As soon as a RPM signal is displayed, pairing of ANT+ RPM transmission is finished.

Proceed with basic settings process:

- Press "SUN" button to enter KM/MILE setting.
- Press "FLOW" button to select KM or MILES.
- Press "SUN" button to confirm your selection and to enter gear ratio settings.
- Press "FLOW" button to select between following gear ratios:
 - 1:3.1 for bikes with V-Belt Drive.
(IC3, S-/E-Series).
 - 1:1.0 for IC5 bike.
 - 1:4.3 for KRANKcycle.
- Press "SUN" button to confirm your selection and finish the basic settings process.

BEFORE YOU START

BEFORE YOU START YOUR TRAINING:

- Turn on the ANT+ console by pressing any of the 2 buttons (“SUN” or “FLOW”).
- Test if the ANT+ console properly reads and displays your HR signal transmitted from your personal HR chest belt (analog chest belts will be paired automatically; ANT+ chest belts must be paired manually).

BEFORE YOU START

PROCESS FOR ANT+ HEART RATE PAIRING:

- Press "SUN" button for 3 seconds to enter pairing mode.
- Press "FLOW" button to start ANT+ HR pairing (Get as close as possible to the ANT+ console during ANT+ HR pairing).
- Press "SUN" button to get back to main menu after successful ANT+ HR pairing.
- HR chest transmitter must be moistened prior to use in order to transmit signal.
- The blinking of the heart symbol on the ANT+ console display indicates the reception of a compatible analog or ANT+ HR signal.
- It may take up to 3 seconds before the actual HR data is displayed.

HOW TO OPERATE

RESET USER DATA:

Press "FLOW" button for 3 seconds to reset all currently stored user data such as time, distance and Kcal, average HR and RPM.

ENGAGE LIGHT FUNCTION:

Pressing the "SUN" button briefly during exercise, turns on the display illumination for 5 seconds.

TRAINING INFO:

Select your desired training information displayed on the lower part of the ANT+ console LCD by operating the "FLOW" button briefly during exercise. The display will shift from Time, to Distance, to Kcal and finally to Scan.

If you select the scan mode the display will alternate between Time, Distance, Kcal.

HOW TO OPERATE

WARNING!

Heart Rate monitoring systems may be inaccurate. Over-exercising may result in serious injury or death. If you feel faint stop exercising immediately.

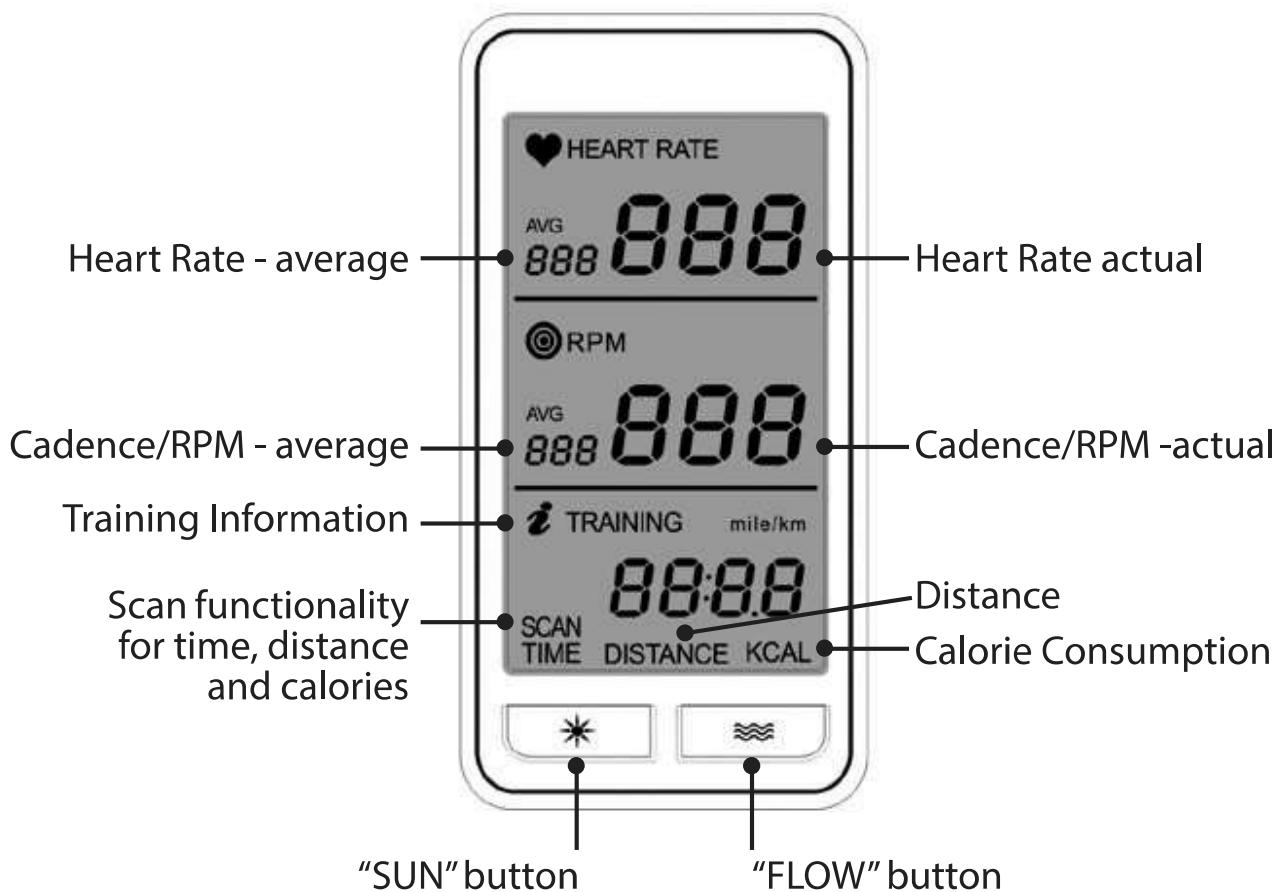

BATTERY EXCHANGE

BATTERY EXCHANGE AND RESETTING OF CONSOLE:

- The symbol  will appear in the upper right corner of the display when the batteries need to be replaced.

To change the batteries, or to reset the ANT+ console in order to resolve any issues to the functioning of the ANT+ console, please proceed as follows:

- Use a screw driver to remove the ANT+ console from its support bracket.
- Remove the batteries of the ANT+ console.
- Press any button on the front of the ANT+ console for at least 10 seconds.
- After RESET reinsert the (new) batteries.
- Test the functionality of the ANT+ console before re-attaching it to its support bracket.

BATTERY EXCHANGE

BATTERY EXCHANGE AND RESETTING OF CADENCE TRANSMITTER:

To change the batteries of the cadence transmitter or to reset the cadence transmitter, please proceed as follows:

- Use a screw driver to remove the cadence transmitter from the bike/KRANKcycle frame.
- Remove the batteries from the cadence transmitter.
- Wait for at least 30 seconds before inserting the (new) batteries.
- Test the functionality of the cadence transmitter before re-attaching it to the bike/KRANKcycle frame.

BATTERY EXCHANGE

THE BATTERIES MUST NOT:

- Come in contact with fire.
- Come in contact with coins or other metal objects.
- Be used together with older batteries.
- Be used together with batteries of another make or type.

If you don't plan to use the equipment for a prolonged period of time, please remove the batteries to avoid any damage to the ANT+ console by leaking or corroding batteries. If batteries have discharged, remove all residue immediately and insert new batteries into the ANT+ console. If you come into contact with residue, avoid contact with eyes and wash hands thoroughly.

BATTERY EXCHANGE

If possible, please use rechargeable batteries to help save the environment. When doing so, please make sure they deliver 1,5 V output. Before disposing of the console, please take the batteries out.

Signed products or batteries with this symbol may not be disposed of in normal domestic



refuse. Please familiarize yourself with relevant local laws or guidelines for the disposal of electrical devices and batteries and act accordingly.



EMAIL: INFO@INDOORCYCLING.COM
WEBSITE: WWW.INDOORCYCLING.COM

Manufactured by: Indoorcycling Group® GmbH
Happurger Str. 84-88 90482 Nuremberg Germany
© 2014 Indoorcycling Group

